

NT *Cutter*®



2025 - 2026

**Time changes. Consumers change.
Our allegiance to users remains unchanged.
We hear your pleas to develop comfort and convenience.
That is our fundamental philosophy.**

Here at NT Inc. , our priority is you

Nippon Transfer Paper Co., Ltd. (the predecessor of NT Inc.) was established in 1953.
In 1961, the original model of the current A-300 was introduced into the market.
In the same year, the brand was named "NT CUTTER".





Original model of A-300

NT Cutter, all the products designed for you

Light-Duty Cutter	04	Circle Cutter	16
Medium-Sized Cutter	08	Others	18
Heavy-Duty Cutter	09	Spare Blade	24
Precision Knife	14	Dresser	28

Light-Duty Cutter



A-301RP

Pastel color editions of the best-selling item A-300
5 pastel colors

Auto-Lock Left & right handed

Spare blade No. 1 ~ 5 ※Pre-installed 1

Packing: Blister pack Unit qty: 100(10×10)

JAN

5-color assorted: 4904011010095 W: 4904011019425
P: 4904011019401 B: 4904011019432
Y: 4904011019418 V: 4904011019449

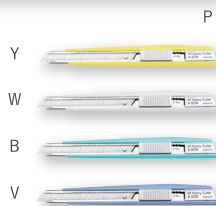

FA-120P

Features internal metal blade housing
5 pastel colors

Left & right handed

Spare blade No. 1 ~ 5 ※Pre-installed 1

Packing: Plastic bag Unit qty: 200(20×10)

JAN

5-color assorted: 4904011010071

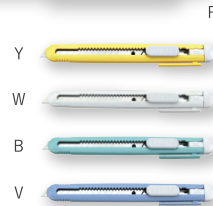

iA-300RP

Advanced model of the best-selling item A-300
5 translucent colors

Auto-Lock Left & right handed

Spare blade No. 1 ~ 5 ※Pre-installed 1

Packing: Blister pack Unit qty: 200(20×10)

JAN

5-color assorted: 4904011010675 G: 4904011019739
R: 4904011019715 B: 4904011019746
O: 4904011019722 Pu: 4904011019753

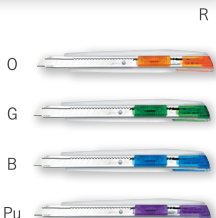

iA-300RSP

iA-300RP(B) cutter with blade disposal case

Auto-Lock Left & right handed

Spare blade No. 1 ~ 5 ※Pre-installed 1

Packing: Blister pack Unit qty: 200(20×10)

JAN

4904011014796



iA-120P

Features internal metal blade housing
5 translucent colors

Left & right handed

Spare blade No. 1 ~ 5 ※Pre-installed 1

Packing: Plastic bag Unit qty: 200(20×10)

JAN

5-color assorted: 4904011010538 G: 4904011019210
R: 4904011019197 B: 4904011019227
O: 4904011019203 Pu: 4904011019234

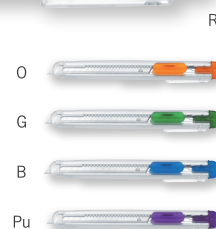

iA-200SP

Features internal metal blade housing
Includes blade disposal case
Unique grip with a wider back end for enhanced comfort

Left & right handed

Spare blade No. 1 ~ 5 ※Pre-installed 1

Packing: Blister pack Unit qty: 200(20×10)

JAN

P: 4904011014819 B: 4904011014826

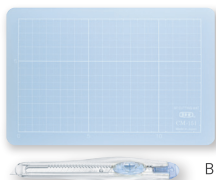

SET-AM350P

Features internal metal blade housing
Unique grip with a wider back end for enhanced comfort
Includes mini portable cutting mat

Left & right handed

Spare blade No. 1 ~ 5 ※Pre-installed 1

Packing: Plastic bag Unit qty: 100(10×10)

JAN

P: 4904011014833 B: 4904011014840



AR-1P(B)

Wide grip for stability
Vivid colors

Auto-Lock Left & right handed

Spare blade No. 1 ~ 5 ※Pre-installed 1

Packing: Blister pack Unit qty: 100(10×10)

JAN

4904011019913



AR30D

30 degree tip blade ideal for precision work
Wide body designed for enhanced grip
Natural earthy colors

Auto-Lock Left & right handed

Spare blade No. 1 ~ 5 8 ※Pre-installed 8

Packing: Blister pack Unit qty: 100(10×10)

JAN

WB: 4904011012570 SG: 4904011012594
LG : 4904011012587



K-200RP

5 metallic colors

Auto-Lock

Spare blade No. 1 ~ 5 ※Pre-installed 1

Packing: Plastic bag Unit qty: 200(20×10)

JAN

5-color assorted: 4904011010477

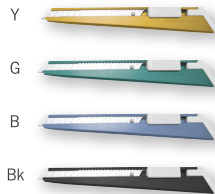

K-200

5 metallic colors

Spare blade No. 1 ~ 5 ※Pre-installed 1

Packing: Paper box Unit qty: 200(20×10)

JAN

5-color assorted: 4904011012013

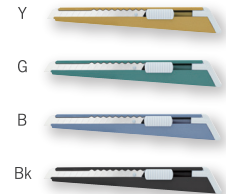

S-202P

Screw-locking to hold blade securely

Screw-Lock Disposal by parts

Spare blade No. 1 ~ 5 ※Pre-installed 1

Packing: Plastic bag Unit qty: 200(20×10)

JAN

4904011010118



A-250RP

Symmetrically designed chemical-resistant holder

Auto-Lock Left & right handed

Spare blade No. 1 ~ 5 ※Pre-installed 1

Packing: Blister pack Unit qty: 200(20×10)

JAN

4904011010439

Light-Duty Cutter



A-300 / A-300P

Best-selling general purpose cutter for decades

With 3 blades

Spare blade No. 1 ~ 5 ※Pre-installed 1

Packing: A-300/Paper box A-300P/Blister pack
Unit qty: 200 (20×10)

| JAN

A-300: 4904011012020 A-300P: 4904011010026



A-300R / A-300RP

Advanced model of the best-selling item A-300

Auto-Lock Left & right handed

Spare blade No. 1 ~ 5 ※Pre-installed 1

Packing: A-300R/Paper box A-300RP/Blister pack
Unit qty: 200 (20×10)

| JAN

A-300R: 4904011012129 A-300RP: 4904011010125



eA-300

100% recycled resin holder

Recycled material With 3 blades

Spare blade No. 1 ~ 5 ※Pre-installed 1

Packing: Paper box Unit qty: 200 (20×10)

| JAN

4904011012228



MNCR-A1

Extra sharp black blade
Black & White

Auto-Lock Left & right handed

Spare blade No. 1 ~ 5 ※Pre-installed 5

Packing: Blister pack Unit qty: 200 (20×10)

| JAN

4904011012242



A-300GR / A-300GRP

Durable and light aluminum die-cast grip

Auto-Lock Left & right handed Metal body

Spare blade No. 1 ~ 5 ※Pre-installed 1

Packing: A-300GR/Paper box A-300GRP/Blister pack
Unit qty: 200 (20×10)

| JAN

A-300GR: 4904011012068 A-300GRP: 4904011010767

Light-Duty Cutter



PMGA-EV01

Aluminum die-cast grip in luxurious metallic red
Extra sharp black blade

Auto-Lock Left & right handed Metal body

Spare blade No. 1 ~ 5 ※Pre-installed 5

Packing: Blister pack Unit qty: 200 (20×10)

JAN
4904011012273



PMGA-EV02

Aluminum die-cast grip in metallic pearl black
30 degree tip black blade , perfect for precision work

Auto-Lock Left & right handed Metal body

Spare blade No. 1 ~ 5 9 ※Pre-installed 9

Packing: Blister pack Unit qty: 100 (10×10)

JAN
4904011012358

Multi-Blade Cartridge Cutter

Cartridge accomodates up to 5 blades for consecutive use



1 Push the slider up

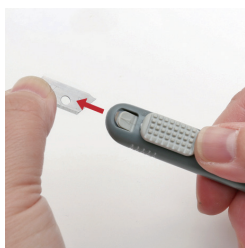

2 Pull the blade out



3 Place the slider back



4 New blade automatically pops up into position



A-551P

Holds up to 5 blades for consecutive use
Rounded top to reduce the risk of scratching

Multi-blade cartridge With 2 blades

Spare blade No. 1 ~ 5 ※Pre-installed 1

Packing: Blister pack Unit qty: 100 (10×10)

JAN
4904011010200



A553P

Popular tool for vehicle wrap with
30 degree tip blade for precision work
Rounded top to reduce the risk of scratching
Holds up to 5 blades for consecutive use

Multi-blade cartridge With 2 blades

Spare blade No. 1 ~ 5 8 ※Pre-installed 6

Packing: Blister pack Unit qty: 100 (10×10)

JAN
4904011010194



A-1000RP

Holds up to 5 blades for consecutive use
Durable and light aluminum die-cast grip

Auto-Lock Multi-blade cartridge
Metal body With 2 blades

Spare blade No. 1 ~ 5 ※Pre-installed 1

Packing: Blister pack Unit qty: 100 (10×10)

JAN
4904011010224



A-1P

High-quality stainless steel holder for both handed
30 degree tip blade applicable

Auto-Lock Left & right handed With 3 blades

Spare blade No. 1 ~ 5 8 ※Pre-installed 1

Packing: Blister pack Unit qty: 100(10×10)

JAN

4904011010156



AD-2P

30 degree tip blade ideal for precision work
High-quality stainless steel holder for both handed
Normal 58 degree tip blade applicable

Auto-Lock Left & right handed

Spare blade No. 1 ~ 5 8 ※Pre-installed 8

Packing: Blister pack Unit qty: 100(10×10)

JAN

4904011010255



SET-AD950P

30 degree tip blade ideal for precision work
High-quality stainless steel holder for both handed
Value set of cutter & 10 spare blades

Auto-Lock Left & right handed

Spare blade No. 1 ~ 5 8 ※Pre-installed 8

Packing: Blister pack Unit qty: 100(10×10)

JAN

4904011010934



STL-ONE

Ideal for use in cutting window-tinting film
Stainless steel blade is highly resistant to rust
and lessens the possibility of scratching car windows
Excellent organic solvent resistance

Auto-Lock Left & right handed Stainless steel blade

Washable

Spare blade No. 1 ~ 5 8 ※Pre-installed 3

Packing: Blister pack Unit qty: 100(10×10)

JAN

4904011010491



SA-400GRP

Light-duty thin (0.25mm) black blade
Auto-retractable slider for safety
Slim and long design

Left & right handed Quick return Metal body

Spare blade No. 6 7 ※Pre-installed 6

Packing: Plastic bag Unit qty: 200(20×10)

JAN

4904011010866



H-1P

Medium size utility cutter
Thin 0.25mm blade
High-quality stainless housing and durable aluminum die-cast grip

Auto-Lock Left & right handed Metal body

Spare blade No. 10

Packing: Blister pack Unit qty: 100(10×10)

JAN

4904011010507



H-2P

Medium size utility cutter
High-quality stainless housing and durable aluminum die-cast grip

Auto-Lock Left & right handed Metal body

Spare blade No. 11 12 ※Pre-installed 11

Packing: Blister pack Unit qty: 100(10×10)

JAN

4904011010514



PMGH-EV02

Medium size utility cutter
Aluminum die-cast grip in metallic pearl black
High-quality stainless housing
Extra sharp black blade

Auto-Lock Left & right handed Metal body

Spare blade No. 11 12 ※Pre-installed 12

Packing: Blister pack Unit qty: 100(10×10)

JAN

4904011012365

Heavy-Duty Cutter



PMGL-EV01

Aluminum die-cast grip in luxurious metallic red
Black blade

Screw-Lock Rubber grip Metal body

Spare blade No. 13 ~ 24 57 ※Pre-installed 16

Packing: Blister pack Unit qty: 100(10×10)

| JAN

4904011012280



PMGL-EV01R

Aluminum die-cast grip in luxurious metallic red
Black blade

Auto-Lock Rubber grip Metal body

Spare blade No. 13 ~ 24 57 ※Pre-installed 16

Packing: Blister pack Unit qty: 100(10×10)

| JAN

4904011012297



PMGL-EV02

Aluminum die-cast grip in metallic pearl black
Extra sharp black blade

Screw-Lock Rubber grip Metal body

Spare blade No. 13 ~ 24 57 ※Pre-installed 18

Packing: Blister pack Unit qty: 100(10×10)

| JAN

4904011012372



PMGL-EV02R

Aluminum die-cast grip in metallic pearl black
Extra sharp black blade

Auto-Lock Rubber grip Metal body

Spare blade No. 13 ~ 24 57 ※Pre-installed 18

Packing: Blister pack Unit qty: 100(10×10)

| JAN

4904011012389



MNCR-L1

Black blade
Black & White

Screw-Lock

Spare blade No. 13 ~ 24 57 ※Pre-installed 16

Packing: Blister pack Unit qty: 100(10×10)

| JAN

4904011012259



MNCR-L1R

Black blade
Black & White

Auto-Lock

Spare blade No. 13 ~ 24 57 ※Pre-installed 16

Packing: Blister pack Unit qty: 100(10×10)

| JAN

4904011012266

Light-Duty Cutter

Medium-Sized Cutter

Heavy-Duty Cutter

Heavy-Duty Cutter



L-500G / L-500GP

Durable and light aluminum die-cast grip
Sturdy metal slider

Screw-Lock Metal body

Spare blade No. 13 ~ 24 57 ※Pre-installed 13

Packing: L-500G/Paper box L-500GP/Blister pack
Unit qty: 100 (10×10)

JAN

L-500G: 4904011012402 L-500GP: 4904011010804



L-500GR / L-500GRP

Durable and light aluminum die-cast grip

Auto-Lock Metal body

Spare blade No. 13 ~ 24 57 ※Pre-installed 13

Packing: L-500GR/Paper box L-500GRP/Blister pack
Unit qty: 100 (10×10)

JAN

L-500GR: 4904011012419 L-500GRP: 4904011010811



L-550GP

Durable and light aluminum die-cast grip
One touch metal slider

Screw-Lock Metal body

Spare blade No. 13 ~ 24 57 ※Pre-installed 13

Packing: Blister pack Unit qty: 100 (10×10)

JAN

4904011010873



L-500 / L-500P

Most popular basic heavy-duty cutter
Sturdy metal slider

Screw-Lock With 3 blades

Spare blade No. 13 ~ 24 57 ※Pre-installed 13

Packing: L-500/Paper box L-500P/Blister pack
Unit qty: 100 (10×10)

JAN

L-500: 4904011012303 L-500P: 4904011010309



L-550 / L-550P

Unique jaggy design for easy grip
One touch metal slider

Screw-Lock With 3 blades

Spare blade No. 13 ~ 24 57 ※Pre-installed 13

Packing: L-550/Paper box L-550P/Blister pack
Unit qty: 100 (10×10)

JAN

L-550: 4904011012310 L-550P: 4904011010316



L-450P

Designed for comfortable grip

Screw-Lock

Spare blade No. 13 ~ 24 57 ※Pre-installed 13

Packing: Blister pack
Unit qty: 100 (10×10)

JAN

4904011010293

Multi-Blade Cartridge Cutter

Cartridge accommodates up to 6 blades for consecutive use



1 Push the slider up



2 Pull the blade out



3 Place the slider back



4 New blade automatically pops up into position



L-2500GRP

Holds up to 6 blades for consecutive use
Auto-lock slider & screw on top to hold blade securely
Durable and light aluminum die-cast grip

Multi-blade cartridge Auto-Lock Point screw lock

Rubber grip Metal body With 2 blades

Spare blade No. 13 14 15 ※Pre-installed 13

Packing: Blister pack Unit qty: 100(10x10)

JAN

4904011014932



L-2000RP

Holds up to 6 blades for consecutive use
Auto-lock slider & screw on top to hold blade securely
Durable and light aluminum die-cast grip

Multi-blade cartridge Auto-Lock Point screw lock

Metal body With 2 blades

Spare blade No. 13 14 15 ※Pre-installed 13

Packing: Blister pack Unit qty: 100(10x10)

JAN

4904011010392



L-2000P

Holds up to 6 blades for consecutive use
Screw on top to hold blade securely
Durable and light aluminum die-cast grip

Multi-blade cartridge Point screw lock Metal body

With 2 blades

Spare blade No. 13 14 15 ※Pre-installed 13

Packing: Blister pack Unit qty: 100(10x10)

JAN

4904011010354



L-700RP

Holds up to 6 blades for consecutive use
Auto-lock slider & screw on top to hold blade securely
Chemical-resistant holder

Multi-blade cartridge Auto-Lock Point screw lock

With 2 blades

Spare blade No. 13 14 15 ※Pre-installed 13

Packing: Blister pack Unit qty: 100(10x10)

JAN

R: 4904011019371 Bk: 4904011019388



Heavy-Duty Cutter



R

iL-120P

Features internal metal blade housing
5 translucent colors

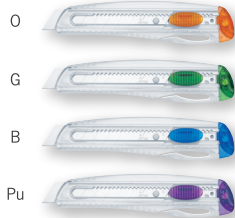

Spare blade No. 13 ~ 24 57 ※Pre-installed 13

Packing: Plastic bag Unit qty: 200 (20×10)

| JAN

5-color assorted: 4904011010545 G : 4904011019265
R : 4904011019241 B : 4904011019272
O : 4904011019258 Pu : 4904011019289



P

ZL-1P

Compact cutter with segment-free short blade
Great for cardboard cutting, packing and unpacking of goods

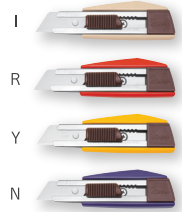

Auto-Lock

Spare blade No. 20 22 23 ※Pre-installed 22

Packing: Plastic bag Unit qty: 100 (10×10)

| JAN

P : 4904011014550 Y : 4904011014581
I : 4904011014567 N : 4904011014598
R : 4904011014574



eL-500

100% recycled resin holder
Sturdy metal slider

Recycled material Screw-Lock With 3 blades

Spare blade No. 13 ~ 24 57 ※Pre-installed 13

Packing: Paper box Unit qty: 100 (10×10)

| JAN

4904011012235



FU2-L

"Super Basic"
Auto-lock slider
Basic heavy-duty cutter

Auto-Lock

Spare blade No. 13 ~ 24 57 ※Pre-installed 13

Packing: Plastic bag Unit qty: 100 (10×10)

| JAN

4904011010040



R

L-300RP

4 vivid colors



Auto-Lock

Spare blade No. 13 ~ 24 57 ※Pre-installed 13

Packing: Plastic bag Unit qty: 200 (20×10)

| JAN

4-color assorted: 4904011010262

Heavy-Duty Cutter



L5506P

“Tough & Sturdy”
Sturdy 0.6mm thick blade for stable work
Unique jaggy design for easy grip

Screw-Lock

Spare blade No. **13** ~ **24** **57** ※Pre-installed **17**

Packing: Blister pack Unit qty: 100(10×10)

| JAN

4904011010576



L5506RP

“Tough & Sturdy”
Sturdy 0.6mm thick blade for stable work
Unique jaggy design for easy grip

Auto-Lock

Spare blade No. **13** ~ **24** **57** ※Pre-installed **17**

Packing: Blister pack Unit qty: 100(10×10)

| JAN

4904011010583



SL10P

Auto-retractable slider for safety
Segmented-short blade
Eye-catching orange grip

Quick return

Spare blade No. **19** ~ **24** ※Pre-installed **19**

Packing: Blister pack Unit qty: 100(10×10)

| JAN

4904011019074



SL20P

Auto-retractable slider for safety
Includes both hook and segmented-short blades
Eye-catching orange grip

Quick return

Spare blade No. **19** ~ **24** ※Pre-installed **19** **20**

Packing: Blister pack Unit qty: 100(10×10)

| JAN

4904011019081



SL30P

Auto-retractable slider for safety
Segment-free & round tip short blade
Eye-catching orange grip

Quick return **Round tip blade**

Spare blade No. **19** ~ **24** ※Pre-installed **21**

Packing: Blister pack Unit qty: 100(10×10)

| JAN

4904011019098



SL-700GP

Auto-retractable slider for safety
Slim and long design
Durable and light aluminum die-cast grip

Quick return **Metal body**

Spare blade No. **13** ~ **24** **57** ※Pre-installed **13**

Packing: Plastic bag Unit qty: 100(10×10)

| JAN

4904011010798

Precision Knife



D-400 / D-400P

Most popular basic design knife
Pen-style holder ϕ 9mm

Disposal by parts With 5 for each 45 and 30 degree blades

Spare blade No. 26 ~ 31 ※Pre-installed 26 27

Packing: D-400/Paper box D-400P/Blister pack
Unit qty: 200 (20×10)

| JAN

D-400: 4904011012600 D-400P: 4904011010606



D-401P

Most popular basic design knife
Pen-style holder ϕ 9mm
5 pastel colors



Disposal by parts With 5 for each 45 and 30 degree blades

Spare blade No. 26 ~ 31 ※Pre-installed 26 27

Packing: Blister pack Unit qty: 200 (20×10)

| JAN

P: 4904011014857 G: 4904011014871
W: 4904011014864 V: 4904011014895
B: 4904011014888



D-400GP

Durable and light aluminum die-cast holder
Pen-style holder ϕ 9mm

With 5 for each 45 and 30 degree blades

Disposal by parts Metal body

Spare blade No. 26 ~ 31 ※Pre-installed 26 27

Packing: Blister pack Unit qty: 200 (20×10)

| JAN

4904011010828



D-500GP

Durable and light aluminum die-cast holder
 ϕ 11mm rubber grip for comfort

With 5 for each 45 and 30 degree blades

Disposal by parts Metal body Rubber grip

Spare blade No. 26 ~ 31 ※Pre-installed 26 27

Packing: Blister pack Unit qty: 200 (20×10)

| JAN

4904011010736



DS-800P

Super slim ϕ 6mm design knife
Durable and light ground aluminum holder
Includes applicable needle

With 5 for 30 degree blades Disposal by parts Metal body

Spare blade No. 26 ~ 31 ※Pre-installed 27

Packing: Blister pack Unit qty: 200 (20×10)

| JAN

4904011010620



DK1P

Ideal for use in KIRIE (paper cutting art)
Slim ϕ 6mm holder ideal for delicate cutting
Sturdy and beautiful anodized aluminum holder



With 20 for 30 degree blades Disposal by parts Metal body

Spare blade No. 26 ~ 31 ※Pre-installed 27

Packing: Plastic box Unit qty: 100 (10×10)

| JAN

PG: 4904011012549 YG: 4904011012563
WG: 4904011012556



SW-600GP

360 degree rotating blade for cutting smooth curves
Durable and light aluminum die-cast holder
Ø11mm rubber grip for comfort

With 5 for 30 degree blades

Disposal by parts Metal body Rubber grip

Spare blade No. 27 28 29 31 ※Pre-installed 27

Packing: Blister pack Unit qty: 100(10×10)

| JAN

4904011010781

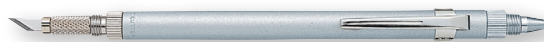

D-1000P

When not in use

Dual end holder for blade and needle
Reversible on both ends to store blade and needle safely
Durable and light ground aluminum holder

With 5 for each 45 and 30 degree blades

Disposal by parts Metal body

Spare blade No. 26 ~ 31 ※Pre-installed 26 27

Packing: Blister pack Unit qty: 100(10×10)

| JAN

4904011010637



D-300P

Hexagonal cream holder

Disposal by parts With 5 for each 45 and 30 degree blades

Spare blade No. 26 ~ 31 ※Pre-installed 26 27

Packing: Blister pack Unit qty: 200(20×10)

| JAN

4904011010590



eD-400

100% recycled resin holder
Pen-style holder Ø9mm

With 5 for each 45 and 30 degree blades

Disposal by parts Recycled material

Spare blade No. 26 ~ 31 ※Pre-installed 26 27

Packing: Paper box Unit qty: 200(20×10)

| JAN

4904011012617



DL-400P

Larger blade with 35 degree tip
Hexagonal cream holder

Disposal by parts With 5 blades

Spare blade No. 32

Packing: Blister pack Unit qty: 200(20×10)

| JAN

4904011010644



eDL-400

Larger blade with 35 degree tip
100% recycled resin holder
Hexagonal holder

Disposal by parts With 5 blades Recycled material

Spare blade No. 32

Packing: Paper box Unit qty: 200(20×10)

| JAN

4904011012624

Circle Cutter

POINT Importance when using circle cutter

Cut little by little by turning a couple of times until it cuts through.

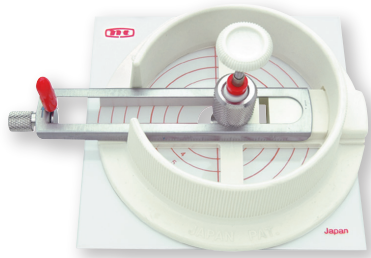

C-1500P $\phi 1.8\sim 17\text{cm}$

Light-duty circle cutter
Leaving no trace of center pin mark
Useful centering guide to assist in finding the center point

With 6 blades

Spare blade No. **26** **30** ※Pre-installed **26**

Packing: Blister pack Unit qty: 10

| JAN

4904011011139

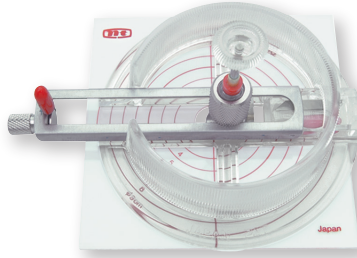

iC-1500P $\phi 1.8\sim 17\text{cm}$

Light-duty circle cutter Translucent body
Leaving no trace of center pin mark
Useful centering guide to assist in finding the center point

With 6 blades

Spare blade No. **26** **30** ※Pre-installed **26**

Packing: Blister pack Unit qty: 10

| JAN

4904011011467

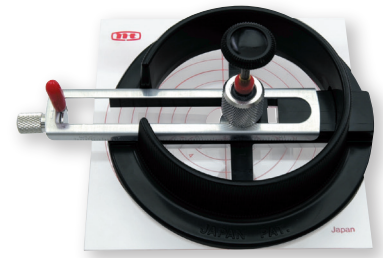

eC-1500P $\phi 1.8\sim 17\text{cm}$

Light-duty circle cutter Recycled resin body
Leaving no trace of center pin mark
Useful centering guide to assist in finding the center point

Recycled material With 6 blades

Spare blade No. **26** **30** ※Pre-installed **26**

Packing: Blister pack Unit qty: 10

| JAN

4904011011474

CE-700P $\phi 16\sim 40\text{cm}$

Extension bar for C-1500 circle cutter
Increase diameter up to 40cm

Spare blade No. **26** **30**

Packing: Blister pack Unit qty: 100(10×10)

| JAN

4904011011146



C215P $\phi 2\sim 15\text{cm}$

Light-duty circle cutter
Compact and simple design
Translucent body for better visibility

With 5 blades

Spare blade No. **26** **30** ※Pre-installed **26**

Packing: Blister pack Unit qty: 100(10×10)

| JAN

4904011010521

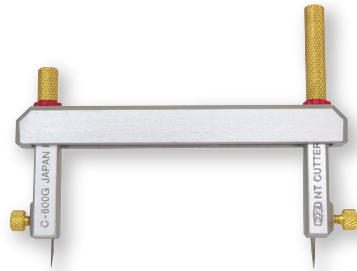

C-700GP $\phi 1\sim 14\text{cm}$

Cutting circles, parallel lines and using as a divider
Blades or needles can be installed in both legs

Metal body With 6 blades & 2 needles

Disposal by parts

Spare blade No. **26** **30** ※Pre-installed **26**

Packing: Plastic bag Unit qty: 100(10×10)

| JAN

4904011011191

When not in use

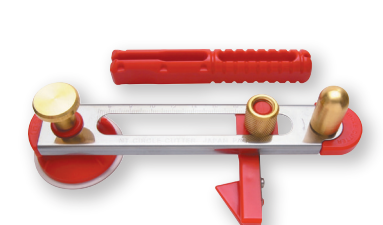

CP-1P $\phi 5\sim 20\text{cm}$

Circle cutter for plastic boards up to 2mm thick e.g. acrylic
Leaving no trace of center pin mark

Up to 2mm thick Sucker fixation

Spare blade No. **45**

Packing: Blister pack Unit qty: 10

| JAN

4904011012532

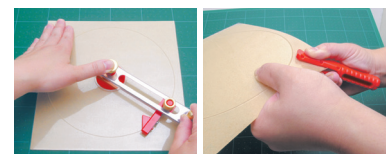

Circle Cutter

POINT Importance when using circle cutter

Cut little by little by turning a couple of times until it cuts through.



C-3000GP $\phi 3\sim 26\text{cm}$

Heavy-duty circle cutter for floor sheets, carpet, thin veneer and more
Durable aluminum die-cast body

Metal body Rubber grip With 2 blades

Spare blade No. **33** **34** ※Pre-installed **33**

Packing: Blister pack Unit qty: 10

| JAN

4904011011177



C-2500P $\phi 3\sim 16\text{cm}$

Heavy-duty circle cutter for floor sheets, carpet, thin veneer and more

With 2 blades

Spare blade No. **33** **34** ※Pre-installed **33**

Packing: Blister pack Unit qty: 10

| JAN

4904011011153



CE-1000P $\phi 15\sim 23\text{cm}$

Extension bar for C-2500 circle cutter
Increase diameter up to 23cm

Spare blade No. **33** **34**

Packing: Blister pack Unit qty: 100 (10x10)

| JAN

4904011011160



C-2000P $\phi 3\sim 22\text{cm}$

Circle cutter for fabric such as felt, denim, lace and more
Leaving no trace of center pin mark

Spare blade No. **39**

Packing: Blister pack Unit qty: 10

| JAN

4904011012518

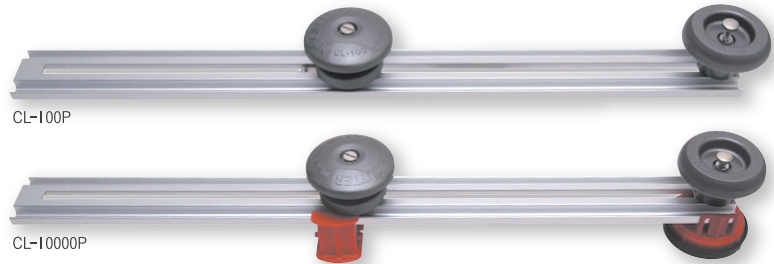

CL-100P $\phi 10\sim 100\text{cm}$

Heavy-duty, large circle cutter
Ideal for cutting floor sheets, carpet, thin veneer and more

Metal body With BC-400P & BC-IP blades

Spare blade No. **33** **34**

Packing: Plastic box Unit qty: 1

| JAN

4904011013164

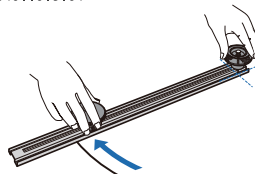

CL-10000P $\phi 20\sim 100\text{cm}$

Large circle cutter for fabric such as felt, denim, lace and more
Great for table cloths and seat covers
Leaving no trace of center pin mark

Metal body With 2 freestyle & 1 wavy blade

Spare blade No. **40** **41** **42** ※Pre-installed **40** **42**

Packing: Plastic box Unit qty: 1

| JAN

4904011012525





RO-2P cut line

Rolling cutter for freestyle cuts
Ideal for cutting fabric, leather and film

Left & right handed

Spare blade No. **40** **41** **42** ※Pre-installed **40**

Packing: Blister pack Unit qty: 100(10×10)

JAN

4904011011320



SK-2P cut line

Rolling cutter for perforated cuts
Ideal for tickets or whenever
perforation is needed

Left & right handed Stainless steel blade

Spare blade No. **40** **41** **42** ※Pre-installed **41**

Packing: Blister pack Unit qty: 100(10×10)

JAN

4904011011337



WA-2P cut line

Rolling cutter for wavy cuts
Ideal for decorative lines on paper
or fabric pinking

Left & right handed Stainless steel blade

Spare blade No. **40** **41** **42** ※Pre-installed **42**

Packing: Blister pack Unit qty: 100(10×10)

JAN

4904011011344



RO-1000GP cut line

Rolling cutter with large $\phi 45$ mm blade
Ideal for cutting fabric, leather and film
Cuts on both pull and push by changing
the position of the protector cap

Left & right handed Metal body Disposal by parts

Spare blade No. **43**

Packing: Blister pack Unit qty: 100(10×10)

JAN

4904011010880



M-500 / M-500P

Plastic cutter
Two blades to score and to cut
In-handle blade storage

Disposal by parts

Spare blade No. **44** **45**

Packing: M-500/Paper box M-500P/Blister pack Unit qty: 100(10×10)

JAN

M-500: 4904011013058 M-500P: 4904011011054



P-500GP

Large plastic cutter
Aluminum grip with integrated plastic blade storage case

Screw-Lock Metal body

Spare blade No. **46**

Packing: Blister pack Unit qty: 100(10×10)

JAN

4904011010897



SC-1P

28mm wide stainless blade scraper
Excellent chemical resistance
Ideal for removing dirt from walls and floors,
and peeling paint

Stainless steel blade Disposal by parts

Spare blade No. 36 37 38 ※Pre-installed 36

Packing: Blister pack Unit qty: 10

JAN

4904011011276



SC-2P

60mm wide stainless blade scraper
Excellent chemical resistance
Ideal for removing dirt from walls and floors,
and peeling paint

Stainless steel blade Disposal by parts

Spare blade No. 36 37 38 ※Pre-installed 37

Packing: Blister pack Unit qty: 10

JAN

4904011011283



Front: Stainless steel blade



Back: Plastic spatula

QT-1P

Portable mini scraper
Equipped with a stainless steel blade
and a plastic spatula

Stainless steel blade

Packing: Blister pack Unit qty: 200(20×10)

JAN

4904011011269

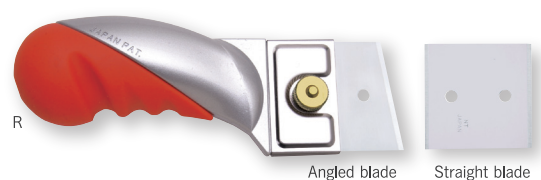

Angled blade

Straight blade

KT-2000GP

Leather knife
Durable and light aluminum die-cast grip
Includes straight blade for trimming &
angled blade for curves

Disposal by parts Rubber grip Metal body

Spare blade No. 54 55 56 ※Pre-installed 54 55

Packing: Blister pack

Unit qty: 10

JAN

R: 4904011010286 Bk: 4904011010279

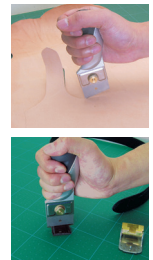

VS-1P

Convenient for woodcraft, DIY
and outdoor activities
Single edged stainless steel blade

Stainless steel blade Washable

Spare blade No. 47

Packing: Blister pack Unit qty: 100(10×10)

JAN

4904011019104



VM-2P

Convenient for woodcraft, DIY
and outdoor activities
Double edged stainless steel blade

Stainless steel blade Washable

Spare blade No. 48 50 ※Pre-installed 48

Packing: Blister pack Unit qty: 100(10×10)

JAN

4904011019111



VL-3P

Convenient for woodcraft, DIY
and outdoor activities
Double edged stainless steel blade

Stainless steel blade Washable

Spare blade No. 49 51 ※Pre-installed 49

Packing: Blister pack Unit qty: 100(10×10)

JAN

4904011019128

Others



Q-100P

Quick knife with replaceable stainless blade
5 colors

Stainless steel blade

Spare blade No. 53

Body size: 67×42×13mm

Packing: Plastic bag Unit qty: 500 (50×10)

JAN

5-color assorted: 4904011011115

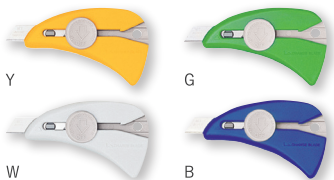

iQ-100P

Quick knife attached with a magnet
5 translucent colors

Quick return Stainless steel blade

Body size: 51×36×18mm

Packing: Plastic bag Unit qty: 500 (50×10)

JAN

5-color assorted: 4904011011238

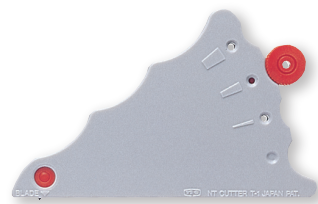
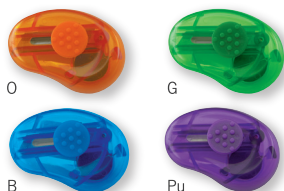

T-1P

Single sheet cutter
Tungsten carbide blade
Adjustable depth blade in 6 positions

Tungsten carbide blade

Packing: Blister pack Unit qty: 5

JAN

4904011011405



OP-101 / OP-101B

Handy opener for any type of packages
5 colors

Stainless steel blade

Body size: 86×61×6mm

Packing: Plastic bag

OP-101/20pcs with display card

OP-101B/20pcs in box

Unit qty: 200 (20×10)

JAN

5-color assorted: 4904011011214

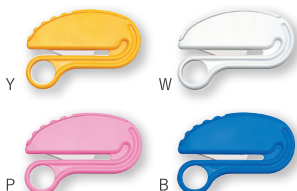

iO-100P / iO-100PB

Handy opener for any type of packages
Attached with a magnet
6 translucent colors

Stainless steel blade

Body size: 86×61×6mm

Packing: Plastic bag

iO-100P/20pcs with display card

iO-100PB/20pcs in box

Unit qty: 200 (20×10)

JAN

6-color assorted: 4904011011498

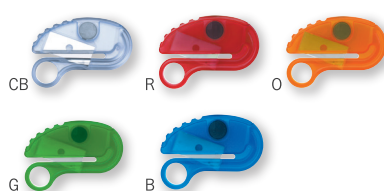



R-1200P

Designed for cutting plastic strapping, packing tape and other packing materials. Safely opens cartons without damaging the contents

With staple remover With 2 blades

Spare blade No. **35**

Packing: Blister pack Unit qty: 10

JAN

4904011011078



HR21P
Leather case designed for R-1200P
(Sold separately)

PD-300P

Reinforced plastic tools to help protect screw heads and nuts from damage. Non-conductive and chemical-resistant. Screwdriver, spanner, tweezers, scraper, hex socket driver and wing nut spanner

Packing: Plastic bag Unit qty: 100 (10x10)

JAN

4904011011955

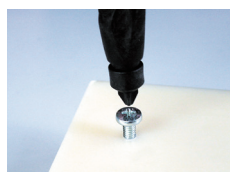
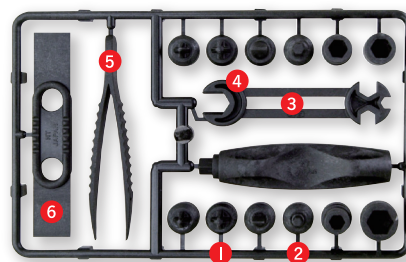

1 Screwdriver



2 Hex Socket Driver



3 Wing nut Spanner

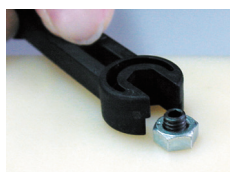

4 Spanner



5 Tweezers



6 Scraper



MAT-45P

Cuts 45 degree bevelled edge on mat board. Convenient for customising decorative frames and architectural models. Includes non-slip rubber sheet

Adjustable up to 6mm thick

Spare blade No. **52**

Packing: Blister pack Unit qty: 10

JAN

4904011011412

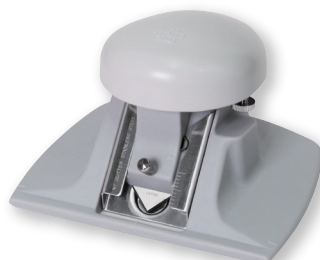
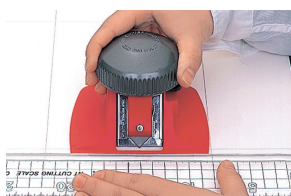

CUT-45

Newly designed grip to fit well in hands. Cuts 45 degree beveled edge on mat and styrene board

Adjustable up to 6mm thick

Spare blade No. **52**

Packing: Paper box Unit qty: 10

JAN

4904011010750

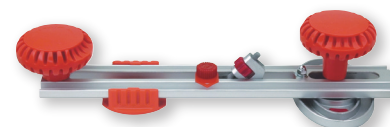

OL-7000GP

Cuts both circles and ovals with 45 degree bevelled edge on mat board to customise decorative frames

Circle : $\phi 20 - 36\text{cm}$

Oval : 17-21cm - 38-42cm With 2 blades

Spare blade No. **33**

Packing: Plastic box Unit qty: 1

JAN

4904011012501



Others

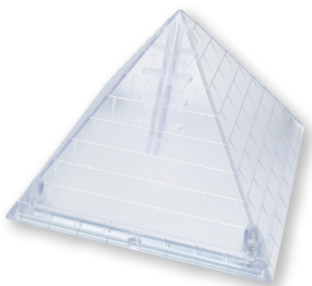

iCD-400P

Pyramid shaped blade disposal case with built-in blade snapper

Disposal by parts

Packing: Plastic bag Unit qty: 10

| JAN

4904011011580



BD-2P

Aluminum blade disposal case with built-in blade snapper
Equipped with a clip to be attached to your belt

Disposal by parts Metal body

Packing: Plastic bag Unit qty: 5

| JAN

4904011011528



BDS-100P

Blade snapper designed for 30 degree snap-off blades
Use with BD-100, BD-50P, BD-1800 and BD-2000

Packing: Plastic bag
Unit qty: 100 (10x10)

| JAN

4904011011597

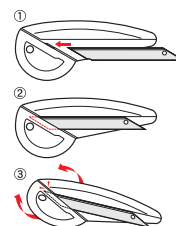

CS-301 / CS-502

Cutting ruler
Available in 2 sizes : 30cm and 50cm
Stainless steel edge for protection of the ruler

Packing: Plastic bag Unit qty: 10

| JAN

CS-301: 4904011013546 CS-502: 4904011013553

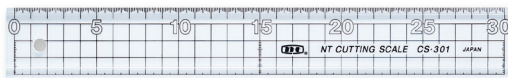

CS-301

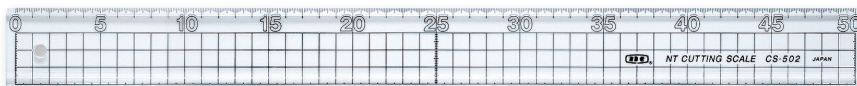

CS-502



HA-11P

High quality, real leather case with belt loop
For A-1P, AD-2P and STL-ONE

Packing: Plastic bag Unit qty: 5

| JAN

4904011011610



HH-12P

High quality, real leather case with belt loop
For H-1P, H-2P, PMGH-EV02 and light-duty cutters

Packing: Plastic bag Unit qty: 5

| JAN

4904011011627



HL-13P

High quality, real leather case with belt loop
For heavy-duty cutters

※Excepting L-2500GRP and SL-700GP

Packing: Plastic bag Unit qty: 5

| JAN

4904011011634



HR21P

High quality, real leather case for R-1200P
Becomes more supple and comfortable to use over time
Convenient keyring tool to replace the blade

Packing: Plastic bag Unit qty: 5

| JAN

4904011011603

CM-22i / CM-30i / CM-45i

(A5: 22×15cm) (A4: 30×22cm) (A3: 45×30cm)

Environmentally friendly poly olefin resin
A5·A4·A3 size, 2mm thick with grids
5 translucent colors

Packing: Plastic bag Unit qty: 20

| JAN

CM-22i	CM-30i	CM-45i
R : 4904011013850	R : 4904011013904	R : 4904011013959
O : 4904011013867	O : 4904011013911	O : 4904011013966
G : 4904011013874	G : 4904011013928	G : 4904011013973
B : 4904011013881	B : 4904011013935	B : 4904011013980
Pu : 4904011013898	Pu : 4904011013942	Pu : 4904011013997

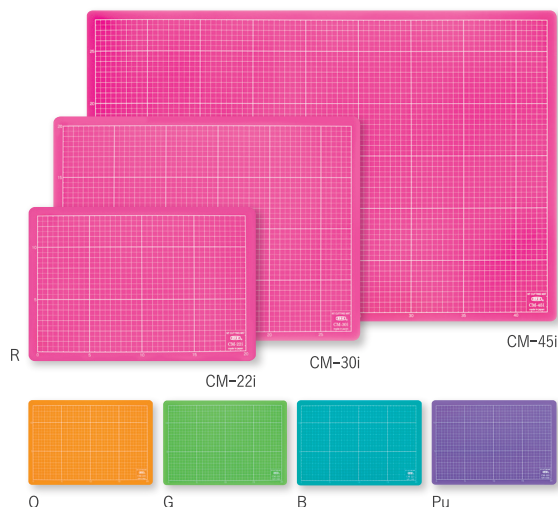

CM-301G / CM-452G / CM-603G / CM-904G

(A4: 30×22cm) (A3: 45×30cm) (A2: 60×45cm) (A1: 90×60cm)

Environmentally friendly poly olefin resin
A4·A3·A2·A1 size, 3mm thick with grids on both sides

Recycled material Double-sided use

Packing: Plastic bag CM-301G, CM-452G, CM-603G: Unit qty: 10 CM-904G: Unit qty: 5

| JAN

CM-301G: 4904011013751
CM-452G: 4904011013768
CM-603G: 4904011013775
CM-904G: 4904011013782

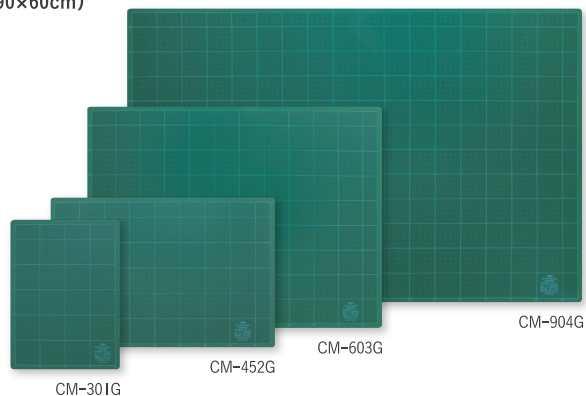
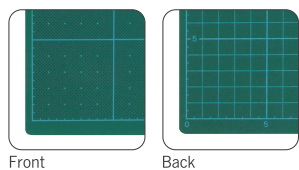

CM-2500 / CM-3500 / CM-5500

(45×29cm) (60×29cm) (90×29cm)

Interconnecting cutting mat for easy sizing and portability
45cm·60cm·90cm length, 3mm thick with grids on both sides
Environmentally friendly poly olefin resin

Recycled material Double-sided use

Packing: Plastic bag Unit qty: 10

| JAN

CM-2500: 4904011013683
CM-3500: 4904011013690
CM-5500: 4904011013706

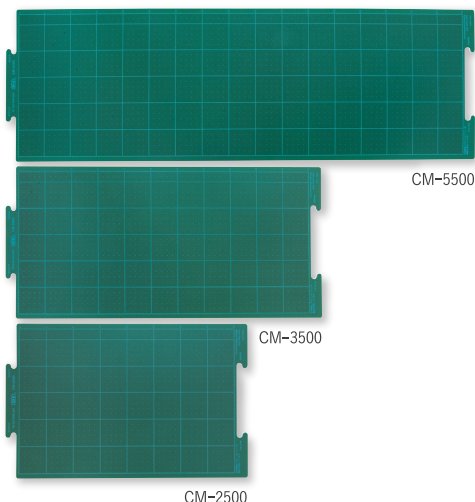
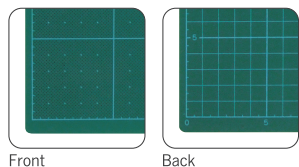

Light-Duty Cutter

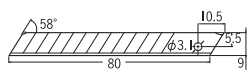

1 3

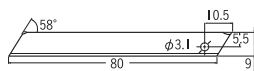

2

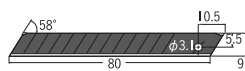

4 5 6 7

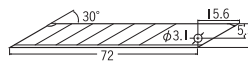

8

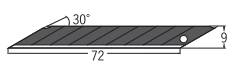

9

Medium-Sized Cutter

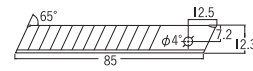

10 11

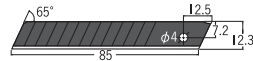

12

※Unit: mm

BA-160 1



Light-duty blades
10 per pack
With disposal case

Disposal by parts
Thickness : 0.38mm

Packing: Plastic case Unit qty: 200 (20×10)
JAN | 4904011016011

BA-160e 1



Light-duty blades
10 per pack
With disposal case
(Recycled resin used)

Disposal by parts
Thickness : 0.38mm

Packing: Plastic case Unit qty: 200 (20×10)
JAN | 4904011016165

BA1P 1



Light-duty blades
10 per pack

Thickness : 0.38mm

Packing: Plastic case Unit qty: 200 (20×10)
JAN | 4904011014215

BA-50P 1



Light-duty blades
50 per pack

Thickness : 0.38mm

Packing: Plastic case Unit qty: 100 (10×10)
JAN | 4904011016066

BA-1400 1



Light-duty blades
100 per pack

Thickness : 0.38mm

Packing: Plastic case Unit qty: 10
JAN | 4904011016073

BA-4000 1



Light-duty blades
400 per pack

Thickness : 0.38mm

Packing: Cardboard box Unit qty: 1
JAN | 4904011016080

BA-100 1



Light-duty blades
5 per pack

Thickness : 0.38mm

Packing: Plastic bag Unit qty: 1,000 (100×10)
JAN | 4904011026102

BA-170 1



Light-duty blades
10 per pack

Thickness : 0.38mm

Packing: Plastic case Unit qty: 200 (20×10)
JAN | 4904011026126

BA-4000-ON 2



Light-duty blades
Segment-free
400 per pack

Thickness : 0.38mm

Packing: Cardboard box Unit qty: 1
JAN | 4904011016172

BA5SS 3



Light-duty blades
5 per pack
Highly resistant to rust

Stainless steel blade
Thickness : 0.38mm

Packing: Plastic case Unit qty: 200 (20×10)
JAN | 4904011014239

BA-50SS 3



Light-duty blades
50 per pack
Highly resistant to rust

Stainless steel blade
Thickness : 0.38mm

Packing: Plastic case Unit qty: 100 (10×10)
JAN | 4904011016035

BA-300 3



Light-duty blades
6 per pack
Highly resistant to rust

Stainless steel blade
Thickness : 0.38mm

Packing: Vinyl sheath Unit qty: 10
JAN | 4904011016059

BA-51P 4



Light-duty black blades
50 per pack

Thickness : 0.38mm

Packing: Plastic case Unit qty: 100 (10×10)
JAN | 4904011016103

BA13P 5



Light-duty black blades
Extra sharp
10 per pack

Thickness : 0.38mm

Packing: Plastic case Unit qty: 100 (10×10)
JAN | 4904011014154

BA-53P 5



Light-duty black blades
Extra sharp
50 per pack

Thickness : 0.38mm

Packing: Plastic case Unit qty: 100 (10×10)
JAN | 4904011014130

BA-52P 6



Light-duty thin black blades
50 per pack

Thickness : 0.25mm

Packing: Plastic case Unit qty: 100 (10×10)
JAN | 4904011016127

BA-54P 7



Light-duty thin black blades
Extra sharp
50 per pack

Thickness : 0.25mm

Packing: Plastic case Unit qty: 100 (10×10)
JAN | 4904011014147

BAD-21P 8



Light-duty 30 degree
10 per pack
With disposal case

Disposal by parts
Thickness : 0.38mm

Packing: Plastic bag Unit qty: 100 (10×10)
JAN | 4904011014253

BA15P 9



Light-duty black blades
30 degree
10 per pack

Thickness : 0.38mm

Packing: Plastic case Unit qty: 100 (10×10)
JAN | 4904011014161

BH1P 10



Medium size thin blades
20 per pack

Thickness : 0.25mm

Packing: Plastic case Unit qty: 100 (10×10)
JAN | 4904011014192

BH-12 10



Medium size thin blades
50 per pack

Thickness : 0.25mm

Packing: Plastic case Unit qty: 100 (10×10)
JAN | 4904011016516

BH2P 11



Medium size blades
10 per pack

Thickness : 0.38mm

Packing: Plastic case Unit qty: 100 (10×10)
JAN | 4904011014208

BH23P 12



Medium size black blades
Extra sharp
10 per pack

Thickness : 0.38mm

Packing: Plastic case Unit qty: 100 (10×10)
JAN | 4904011014178

Heavy-Duty Cutter

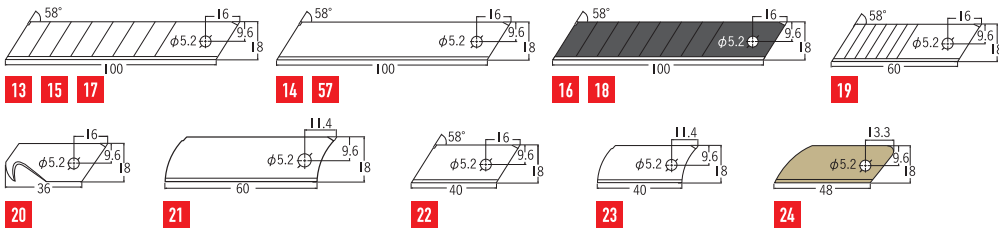

24 Tungsten carbide with titanium coat. Produced by fusing tungsten and carbide powder at high temperature and high pressure. Surface hardness 2350/Hv

Extra Large Cutter

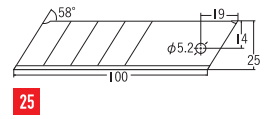

※Unit : mm

BL-300 13



Heavy-duty blades
6 per pack
With disposal case

Disposal by parts
Thickness : 0.45mm

Packing: Plastic case Unit qty: 100 (10x10)
JAN | 4904011016318

BL-300e 13



Heavy-duty blades
6 per pack
With disposal case
(Recycled resin used)

Disposal by parts
Thickness : 0.45mm

Packing: Plastic case Unit qty: 100 (10x10)
JAN | 4904011016462

BL-150P 13



Heavy-duty blades
6 per pack

Thickness : 0.45mm

Packing: Plastic bag Unit qty: 200 (20x10)
JAN | 4904011024290

BL1P 13



Heavy-duty blades
10 per pack

Thickness : 0.45mm

Packing: Plastic case Unit qty: 200 (20x10)
JAN | 4904011014222

BL-50P 13



Heavy-duty blades
50 per pack

Thickness : 0.45mm

Packing: Plastic case Unit qty: 60 (10x6)
JAN | 4904011016356

BL-2300 13



Heavy-duty blades
100 per pack

Thickness : 0.45mm

Packing: Plastic case Unit qty: 10
JAN | 4904011016363

BL-3000 13



Heavy-duty blades
300 per pack

Thickness : 0.45mm

Packing: Cardboard box Unit qty: 1
JAN | 4904011016370

BL-3000-ON 14



Heavy-duty blades
Segment-free
300 per pack

Thickness : 0.45mm

Packing: Cardboard box Unit qty: 1
JAN | 4904011016387

BL5SS 15



Heavy-duty blades
5 per pack
Highly resistant to rust

Stainless steel blade
Thickness : 0.45mm

Packing: Plastic case Unit qty: 200 (20x10)
JAN | 4904011014246

BL-12P 16



Heavy-duty thick black blades
10 per pack

Thickness : 0.5mm

Packing: Plastic case Unit qty: 100 (20x5)
JAN | 4904011016820

BL-51P 16



Heavy-duty thick black blades
50 per pack

Thickness : 0.5mm

Packing: Plastic case Unit qty: 60 (10x6)
JAN | 4904011016417

BL13P 18



Heavy-duty thick black blades
Extra sharp
10 per pack

Thickness : 0.5mm

Packing: Plastic case Unit qty: 100 (10x10)
JAN | 4904011014185

BL06P 17



Heavy-duty thick blades
5 per pack

Thickness : 0.6mm

Packing: Plastic case Unit qty: 200 (20x10)
JAN | 4904011014260

BL06-ON 57



Heavy-duty thick blades
Segment-Free
5 per pack

Thickness : 0.6mm

Packing: Plastic case Unit qty: 200 (20x10)
JAN | 4904011014277

BSL-11P 19



Heavy-duty short blades 60
10 per pack

Thickness : 0.45mm

Packing: Plastic case Unit qty: 100 (10x10)
JAN | 4904011014710

BSL-21P 20



Hook blades
3 per pack

Thickness : 0.5mm

Packing: Plastic case Unit qty: 100 (10x10)
JAN | 4904011014727

BSL31P 21



Heavy-duty short blades 60
Round tip and segment-free
5 per pack

Thickness : 0.45mm

Packing: Plastic case Unit qty: 100 (10x10)
JAN | 4904011014758

BZL11P 22



Heavy-duty short blades 40
Segment-free
6 per pack

Thickness : 0.45mm

Packing: Plastic case Unit qty: 100 (10x10)
JAN | 4904011019586

BZL21P 23



Heavy-duty short blades 40
Round tip and segment-free
5 per pack

Thickness : 0.45mm

Packing: Plastic case Unit qty: 100 (10x10)
JAN | 4904011019579

BTL-3P 24



Heavy-duty blade
Titanium coated
1 per pack

Tungsten carbide blade
Thickness : 0.5mm

Packing: Blister pack
Unit qty: 100 (5x20)
JAN | 4904011018121

BX-400P 25



Heavy-duty extra large blades
5 per pack

Thickness : 0.7mm

Packing: Blister pack Unit qty: 100 (10x10)
JAN | 4904011014451

Precision Knife/Circle Cutter

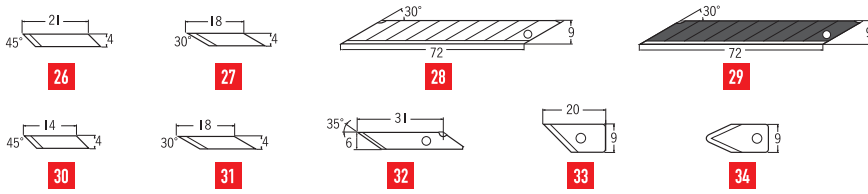

For R-1200P

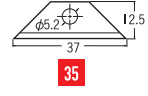

30 31 Tungsten carbide--Produced by fusing tungsten and carbide powder at high temperature and high pressure (Hardness 1600/Hv)

Rolling Cutter

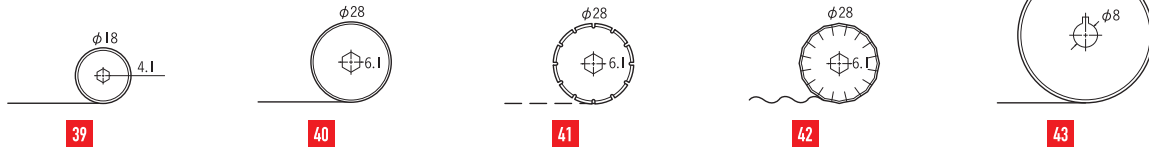

※Unit: mm

BDA-200P 26

Precision 45 degree blades
40 per pack

Packing: Plastic case Unit qty: 100 (10×10)
JAN | 4904011016622



Thickness : 0.38mm

BDC-200P 27

Precision 30 degree blades
40 per pack

Packing: Plastic case Unit qty: 100 (10×10)
JAN | 4904011016639



Thickness : 0.38mm

BD-50P 28

Precision 30 degree blades
Segmented
50 per pack

Packing: Plastic case Unit qty: 100 (10×10)
JAN | 4904011026676



Thickness : 0.38mm

BD-1800 28

Precision 30 degree blades
Segmented
100 per pack
Includes blade snapper

Packing: Plastic case Unit qty: 100
JAN | 4904011016646



Thickness : 0.38mm

BD-100 28

Precision 30 degree blades
Segmented
5 per pack

Packing: Plastic bag Unit qty: 1,000 (100×10)
JAN | 4904011026652



Thickness : 0.38mm

BD-2000 29

Precision 30 degree blades
Black & segmented
100 per pack
Includes blade snapper

Packing: Plastic case Unit qty: 100
JAN | 4904011016660



Thickness : 0.38mm

BSB-03P 30

Precision 45 degree blade
1 per pack

Packing: Blister pack
Unit qty: 100 (5×20)
JAN | 4904011018039



Tungsten carbide blade
Thickness : 0.4mm

BSB-13P 31

Precision 30 degree blade
1 per pack

Packing: Blister pack
Unit qty: 100 (5×20)
JAN | 4904011018060



Tungsten carbide blade
Thickness : 0.4mm

BDL-41P 32

Precision 35 degree large blades
10 per pack

Packing: Plastic case Unit qty: 100 (10×10)
JAN | 4904011014734



Thickness : 0.45mm

BC-400P 33

Circle&Mat cutter blades
10 per pack

Packing: Plastic case Unit qty: 100 (10×10)
JAN | 4904011017070



Thickness : 1.0mm

BC-1P 34

Heavy-duty circle cutter blade
1 per pack

Packing: Plastic case Unit qty: 100 (10×10)
JAN | 4904011019524



Thickness : 1.0mm

BR-400P 35

R-1200 blades
10 per pack

Packing: Plastic case Unit qty: 100 (10×10)
JAN | 4904011017063



Thickness : 0.6mm

BR1801P 39

Rolling ϕ 18 blade
1 per pack

Packing: Plastic bag
Unit qty: 100 (10×10)
JAN | 4904011015403



Thickness : 0.3mm

BR-28P 40

Rolling ϕ 28 blades
2 per pack

Packing: Plastic bag
Unit qty: 100 (10×10)
JAN | 4904011015359



Thickness : 0.3mm

BS-28P 41

Rolling perforating ϕ 28 blades
2 per pack

Packing: Plastic bag
Unit qty: 100 (10×10)
JAN | 4904011015366



Thickness : 0.3mm

BW-28P 42

Rolling wave ϕ 28 blades
2 per pack

Packing: Plastic bag
Unit qty: 100 (10×10)
JAN | 4904011015373



Thickness : 0.3mm

BR-45P 43

Rolling ϕ 45 blade
1 per pack

Packing: Plastic bag
Unit qty: 100 (10×10)
JAN | 4904011015380



Thickness : 0.3mm

Scraper

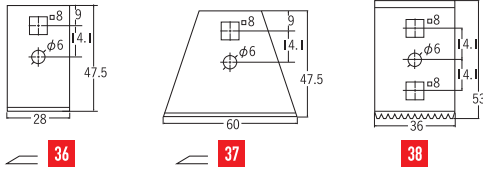

Leather Knife

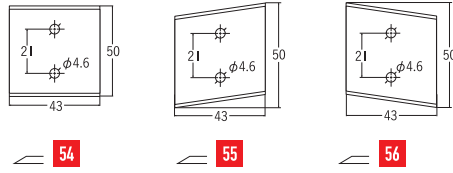

Mat Cutter

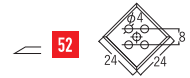

Quick Knife

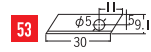

Plastic Cutter

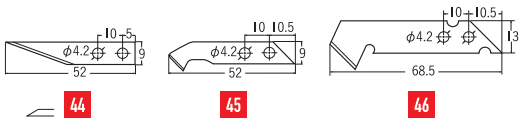

Knife

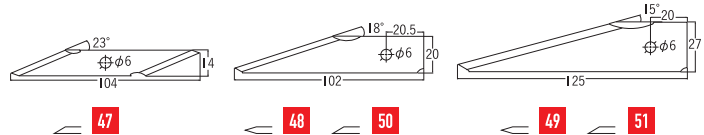

※Unit:mm

BSC-11P 36

Scraper 28mm blades
2 per pack

Packing: Plastic bag
Unit qty: 100(10×10)
JAN | 4904011014673



Thickness : 1.0mm

BSC-21P 37

Scraper 60mm blades
2 per pack

Packing: Plastic bag
Unit qty: 100(10×10)
JAN | 4904011014680



Thickness : 1.0mm

BSC-31P 38

Scraper serrated blades
2 per pack

Packing: Plastic bag
Unit qty: 100(10×10)
JAN | 4904011014697



Thickness : 0.6mm

BM-1P 44

Trimming blades
6 per pack

Packing: Plastic case Unit qty: 100(10×10)
JAN | 4904011017049



Thickness : 0.8mm

BM-2P 45

Plastic scoring blades
6 per pack

Packing: Plastic case Unit qty: 100(10×10)
JAN | 4904011017056



Thickness : 0.8mm

BP-400P 46

Large plastic scoring blades
5 per pack

Packing: Plastic case Unit qty: 100(10×10)
JAN | 4904011014741



Thickness : 0.8mm

BVS-11P 47

Single edge blade S
1 per pack

Packing: Plastic bag Unit qty: 100(10×10)
JAN | 4904011019609



Stainless steel blade
Thickness : 1.0mm

BVM-21P 48

Double edge blade M
1 per pack

Packing: Plastic bag Unit qty: 100(10×10)
JAN | 4904011019616



Stainless steel blade
Thickness : 1.2mm

BVL-31P 49

Double edge blade L
1 per pack

Packing: Plastic bag Unit qty: 100(10×10)
JAN | 4904011019623



Stainless steel blade
Thickness : 1.5mm

BVM-51P 50

Steel single edge blade M
1 per pack

Packing: Plastic bag Unit qty: 100(10×10)
JAN | 4904011019647



Thickness : 1.2mm

BVL-61P 51

Steel single edge blade L
1 per pack

Packing: Plastic bag Unit qty: 100(10×10)
JAN | 4904011019654



Thickness : 1.5mm

BMC-45P 52

Mat Cutter blades
2 per pack

Packing: Plastic bag
Unit qty: 100(10×10)
JAN | 4904011014642



Thickness : 0.3mm

BQ-11P 53

Quick knife blades
2 per pack

Packing: Plastic case
Unit qty: 100(10×10)
JAN | 4904011017001



Stainless steel blade
Thickness : 0.38mm

BKT-300P 54

Straight blades for leather
3 per pack

Packing: Plastic bag
Unit qty: 100(10×10)
JAN | 4904011024719



Thickness : 0.6mm

BKT-350P 55

Angled blades for leather
3 per pack

Packing: Plastic bag
Unit qty: 100(10×10)
JAN | 4904011024726



Thickness : 0.6mm

BKT-LHP 56

Left handed use
Angled blades for leather
3 per pack

Packing: Plastic bag
Unit qty: 100(10×10)
JAN | 4904011024733



Thickness : 0.6mm

Dresser/Sanding tool

S-10P / S-410P

S type flat triangular shape
Plastic handle



Spare plate No. 101 ~ 104

Packing: Blister pack Unit qty: 10
J JAN
S-10P : 4904011030314
S-410P: 4904011030413

S-10GP Disposal by parts

S type flat triangular shape
Durable and light aluminum die-cast handle



Spare plate No. 101 ~ 104

Packing: Blister pack Unit qty: 10
J JAN
4904011030109

M-20P / M-420P

M type flat rectangular shape
Plastic handle



Spare plate No. 105 ~ 108

Packing: Blister pack Unit qty: 10
J JAN
M-20P : 4904011030321
M-420P: 4904011030420

M-20GP Disposal by parts

M type flat rectangular shape
Durable and light aluminum die-cast handle



Spare plate No. 105 ~ 108

Packing: Blister pack Unit qty: 10
J JAN
4904011030116

L-30P / L-430P / L-730P

L type flat large rectangular shape
Plastic handle



Spare plate No. 109 ~ 112

Packing: Blister pack Unit qty: 10
J JAN
L-30P : 4904011030345
L-430P: 4904011030437
L-730P: 4904011030734

L-30GP Disposal by parts

L type flat large rectangular shape
Durable and light aluminum die-cast handle



Spare plate No. 109 ~ 112

Packing: Blister pack Unit qty: 10
J JAN
4904011030123

RS-310P

RS type rounded slim rectangular shape
Plastic handle



Spare plate No. 113

Packing: Blister pack Unit qty: 10
J JAN
4904011031311

RM-320P

RM type rounded triangular shape
Plastic handle



Spare plate No. 114

Packing: Blister pack Unit qty: 10
J JAN
4904011031328

RL-330P

RL type rounded large rectangular shape
Plastic handle



Spare plate No. 115

Packing: Blister pack Unit qty: 10
J JAN
4904011031335

DR-800P

DR ϕ 18 tube shape
Plastic handle



Spare plate No. 116 117

Packing: Blister pack Unit qty: 10
J JAN
4904011031601

DR-1000P

DR ϕ 25 tube shape
Plastic handle



Spare plate No. 116 117

Packing: Blister pack Unit qty: 10
J JAN
4904011031618

Enlarged image of surface

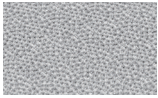

Fine grit
Equivalent to #500~600



Medium grit
Equivalent to #280~400

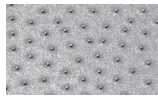

Rough grit
Equivalent to #120~220

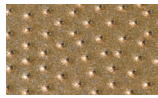

X-extra rough grit
Equivalent to #50~80

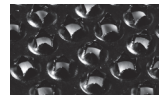

Extra rough grit
Equivalent to #30~40

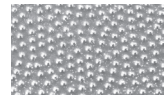

Stainless medium grit
Equivalent to #280~400

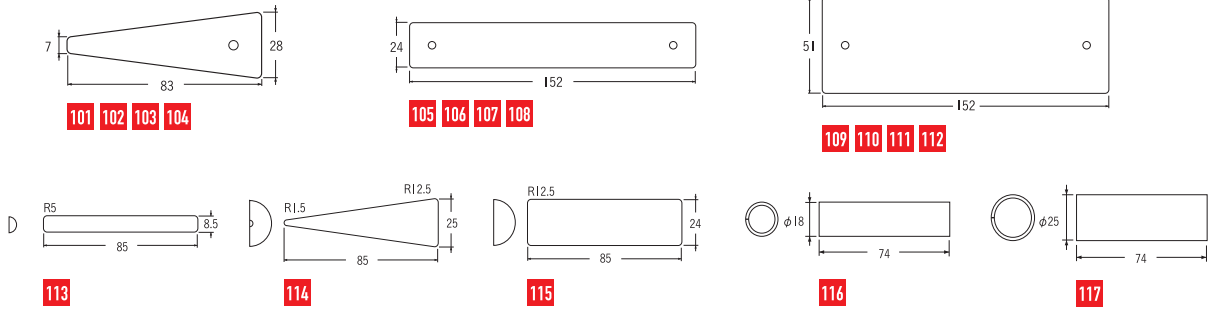

※Unit: mm

Most Durable

High hardness produced by heat treatment.

S-11P 101

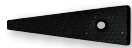

S type (medium grit)
1 per pack

Packing: Plastic bag Unit qty: 100 (10×10)
JAN | 4904011034312

S-411P 103



S type (rough grit)
1 per pack

Packing: Plastic bag Unit qty: 100 (10×10)
JAN | 4904011034411

BS-350P 104



S type (extra rough grit)
1 per pack

Packing: Plastic bag Unit qty: 100 (10×10)
JAN | 4904011034008

M-21P 105



M type (medium grit)
1 per pack

Packing: Plastic bag Unit qty: 100 (10×10)
JAN | 4904011034329

M-421P 107



M type (rough grit)
1 per pack

Packing: Plastic bag Unit qty: 100 (10×10)
JAN | 4904011034428

BM-450P 108



M type (extra rough grit)
1 per pack

Packing: Plastic bag Unit qty: 100 (10×10)
JAN | 4904011034015

L-31P 109



L type (medium grit)
1 per pack

Packing: Plastic bag Unit qty: 100 (10×10)
JAN | 4904011034343

L-431P 111



L type (rough grit)
1 per pack

Packing: Plastic bag Unit qty: 100 (10×10)
JAN | 4904011034435

L-731P 112



L type (extra rough grit)
1 per pack

Packing: Plastic bag Unit qty: 100 (10×10)
JAN | 4904011034732

RS-311P 113



RS type (medium grit)
1 per pack

Packing: Plastic bag Unit qty: 100 (10×10)
JAN | 4904011035319

RM-321P 114



RM type (medium grit)
1 per pack

Packing: Plastic bag Unit qty: 100 (10×10)
JAN | 4904011035326

RL-331P 115



RL type (medium grit)
1 per pack

Packing: Plastic bag Unit qty: 100 (10×10)
JAN | 4904011035333

BDR-500P 116



DR ϕ 18 type (medium grit)
1 per pack

Packing: Plastic bag Unit qty: 100 (10×10)
JAN | 4904011037306

BDR-700P 117



DR ϕ 25 type (medium grit)
1 per pack

Packing: Plastic bag Unit qty: 50 (5×10)
JAN | 4904011037313

Most Abrasive

Raw stainless is less slippery to file well. Suitable for wet surfaces.

BS-3P 102



S type
(stainless medium grit)
1 per pack

Packing: Plastic bag Unit qty: 100 (10×10)
JAN | 4904011034602

BM-3P 106



M type
(stainless medium grit)
1 per pack

Packing: Plastic bag Unit qty: 100 (10×10)
JAN | 4904011034619

BL-3P 110



L type
(stainless medium grit)
1 per pack

Packing: Plastic bag Unit qty: 100 (10×10)
JAN | 4904011034626

Dresser/Sanding tool

PS-11P

Stainless steel sanding sheet with fine grit
Easily cuts to customise size and shape
1 per pack

54×80mm

Packing: Plastic bag
Unit qty: 100 (10×10)

J JAN
4904011038105



SD-300iP

Disposal by parts Fine grit

Mini dresser SD
Double sided with fine and medium grit

19×53mm

Packing: Blister pack
Unit qty: 100 (10×10)

J JAN
4904011030017



SS-1

Small Dresser
Set with 3 different grit



Packing: Plastic bag
Unit qty: 10

J JAN
4904011033414

SF-11 / SF-12

Small Dresser
Flat straight

10×75mm

Packing: Plastic bag
Unit qty: 10

J JAN
SF-11: 4904011032011 SF-12: 4904011032219

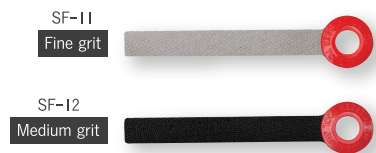

SFT-21 / SFT-22

Small Dresser
Flat tapered

6-20×75mm

Packing: Plastic bag
Unit qty: 10

J JAN
SFT-21: 4904011032035 SFT-22: 4904011032233



SF-21 / SF-22 / SF-23

Small Dresser
Flat straight

20×75mm

Packing: Plastic bag
Unit qty: 10

J JAN
SF-21: 4904011032028
SF-22: 4904011032226
SF-23: 4904011033223



SR-11 / SR-12

Small Dresser
Round straight

Packing: Plastic bag
Unit qty: 10

J JAN
SR-11: 4904011032066 SR-12: 4904011032264

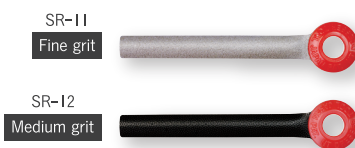

SRT-21 / SRT-22

Small Dresser
Round tapered

Packing: Plastic bag
Unit qty: 10

J JAN
SRT-21: 4904011032080 SRT-22: 4904011032288



SR-21 / SR-22

Small Dresser
Round straight

Packing: Plastic bag
Unit qty: 10

J JAN
SR-21: 4904011032073 SR-22: 4904011032271



SV-11 / SV-12

Small Dresser
V-shaped

Packing: Plastic bag
Unit qty: 10

J JAN
SV-11: 4904011032165 SV-12: 4904011032363



Cutter • Others

A-1000RP 07	CM-301G 23	H-1P 08	L-500GR 10	RO-2P 18
A-1P 08	CM-30i 23	H-2P 08	L-500GRP 10	S-202P 05
A-250RP 05	CM-3500 23	HA-11P 22	L-500P 10	SA-400GRP 08
A-300 06	CM-452G 23	HH-12P 22	L-550 10	SC-1P 19
A-300GR 06	CM-45i 23	HL-13P 22	L-550GP 10	SC-2P 19
A-300GRP 06	CM-5500 23	HR21P 22	L-550P 10	SET-AD950P 08
A-300P 06	CM-603G 23	iA-120P 04	L-700RP 11	SET-AM350P 04
A-300R 06	CM-904G 23	iA-200SP 04	M-500 18	SK-2P 18
A-300RP 06	CP-1P 16	iA-300RP 04	M-500P 18	SL10P 13
A-301RP 04	CS-301 22	iA-300RSP 04	MAT-45P 21	SL20P 13
A-551P 07	CS-502 22	iC-1500P 16	MNCR-A1 06	SL30P 13
A553P 07	CUT-45 21	iCD-400P 22	MNCR-L1 09	SL-700GP 13
AD-2P 08	D-1000P 15	iL-120P 12	MNCR-L1R 09	STL-ONE 08
AR30D 05	D-300P 15	iO-100P 20	OL-7000GP 21	SW-600GP 15
AR-1P 05	D-400 14	iO-100PB 20	OP-101 20	T-1P 20
BD-2P 22	D-400GP 14	iQ-100P 20	OP-101B 20	VL-3P 19
BDS-100P 22	D-400P 14	K-200 05	P-500GP 18	VM-2P 19
C215P 16	D-401P 14	K-200RP 05	PD-300P 21	VS-1P 19
C-1500P 16	D-500GP 14	KT-2000GP 19	PMGA-EV01 07	WA-2P 18
C-2000P 17	DK1P 14	L5506P 13	PMGA-EV02 07	ZL-1P 12
C-2500P 17	DL-400P 15	L5506RP 13	PMGH-EV02 08	
C-3000GP 17	DS-800P 14	L-2000P 11	PMGL-EV01 09	
C-700GP 16	eA-300 06	L-2000RP 11	PMGL-EV01R 09	
CE-1000P 17	eC-1500P 16	L-2500GRP 11	PMGL-EV02 09	
CE-700P 16	eD-400 15	L-300RP 12	PMGL-EV02R 09	
CL-10000P 17	eDL-400 15	L-450P 10	Q-100P 20	
CL-100P 17	eL-500 12	L-500 10	QT-1P 19	
CM-22i 23	FA-120P 04	L-500G 10	R-1200P 21	
CM-2500 23	FUZ-L 12	L-500GP 10	RO-1000GP 18	

Spare Blade

BA-100 24	BA-54P 24	BKT-300P 27	BL5SS 25	BSL-11P 25
BA13P 24	BA5SS 24	BKT-350P 27	BM-1P 27	BSL-21P 25
BA-1400 24	BAD-21P 24	BKT-LHP 27	BM-2P 27	BSL31P 25
BA15P 24	BC-1P 26	BL06P 25	BMC-45P 27	BTL-3P 25
BA-160 24	BC-400P 26	BL06-ON 25	BP-400P 27	BVL-31P 27
BA-160e 24	BD-100 26	BL-12P 25	BQ-11P 27	BVL-61P 27
BA-170 24	BD-1800 26	BL13P 25	BR1801P 26	BVM-21P 27
BA1P 24	BD-2000 26	BL-150P 25	BR-28P 26	BVM-51P 27
BA-300 24	BD-50P 26	BL1P 25	BR-400P 26	BVS-11P 27
BA-4000 24	BDA-200P 26	BL-2300 25	BR-45P 26	BW-28P 26
BA-4000-ON 24	BDC-200P 26	BL-300 25	BS-28P 26	BX-400P 25
BA-50P 24	BDL-41P 26	BL-3000 25	BSB-03P 26	BZL11P 25
BA-50SS 24	BH-12 24	BL-3000-ON 25	BSB-13P 26	BZL21P 25
BA-51P 24	BH1P 24	BL-300e 25	BSC-11P 27	
BA-52P 24	BH23P 24	BL-50P 25	BSC-21P 27	
BA-53P 24	BH2P 24	BL-51P 25	BSC-31P 27	

Dresser • Dresser Spare Plate

BDR-500P 29	L-30P 28	M-421P 29	S-11P 29	SFT-22 30
BDR-700P 29	L-31P 29	PS-11P 30	S-410P 28	SR-11 30
BL-3P 29	L-430P 28	RL-330P 28	S-411P 29	SR-12 30
BM-3P 29	L-431P 29	RL-331P 29	SD-300iP 30	SR-21 30
BM-450P 29	L-730P 28	RM-320P 28	SF-11 30	SR-22 30
BS-350P 29	L-731P 29	RM-321P 29	SF-12 30	SRT-21 30
BS-3P 29	M-20GP 28	RS-310P 28	SF-21 30	SRT-22 30
DR-1000P 28	M-20P 28	RS-311P 29	SF-22 30	SS-1 30
DR-800P 28	M-21P 29	S-10GP 28	SF-23 30	SV-11 30
L-30GP 28	M-420P 28	S-10P 28	SFT-21 30	SV-12 30



NT Incorporated

OFFICE:4-3-29 NAKANO
HIGASHISUMIYOSHI-KU
OSAKA JAPAN
PHONE:+81-6-6702-1551

www.ntcutter.co.jp/en

Made in Osaka, Japan



Website



YouTube

Specifications are subject to change without prior notice.

The actual colors of the products may be different from the colors shown in the catalogue. Information provided is accurate as of January 2025.