

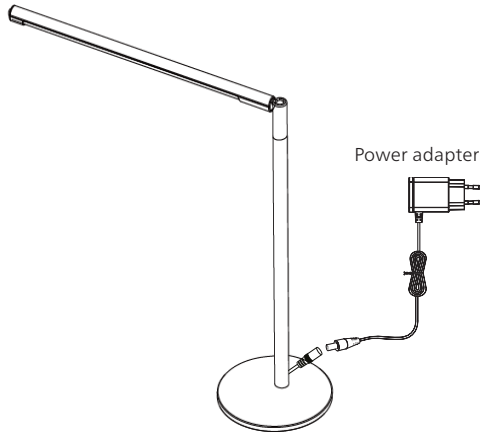

# Aura



## Operation

Press the multi-function switch at the end of the lamp head to turn on/off and control the lamp.

- short press cycle: On > 3 color temperatures: 6000, 2800, 4000K > Off

- long press: stepless dimming 

Memory function: previous dimming level is stored and is recalled at following turn on

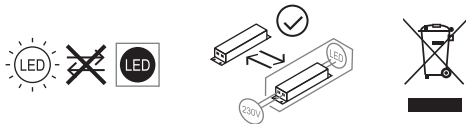

**styro ag**  
 Frauholzstr. 27, CH-6422 Steinen  
 Tel. +41 (0)41 833 80 10  
 info@styro.ch | www.styro.ch

**EU Distributor | styro GmbH**  
 Industriestr. 2, D-91583 Schillingsfürst  
 Tel. +49 9868 98949-0  
 verkauf@styro.de | www.styro.de  
 produkte@styro.de



## Assembly

**HANSA**  
by styro

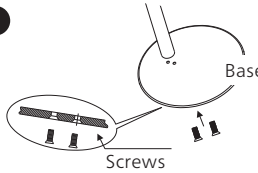
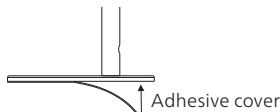
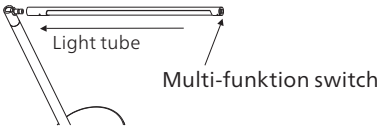
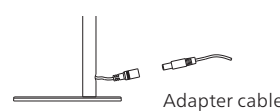

- 1  Base  
Screws
- 2  Adhesive cover
- 3  Light tube  
Multi-funktion switch
- 4  Adapter cable

## Lamp adjustments

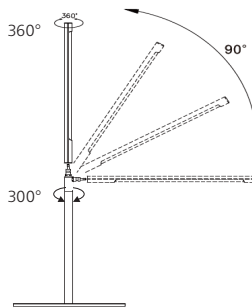

SP20251027



## Technical data

Voltage:	AC 100-240 V, 50-60 Hz
Lighting power:	8 W
Luminous flux:	400 lm
Colour temp.:	2800, 4000, 6000 K
Protection class:	II (w/o adapter: III)
Ingress protection:	IP20
Cable:	1.5 m
Model number:	41-5011.005 / 006

This product contains a light source of energy efficiency class F

The construction of the luminaire does not allow the lighting source to be replaced, as there is a risk of damaging the luminaire. The operating device is in the adapter.

# Aura

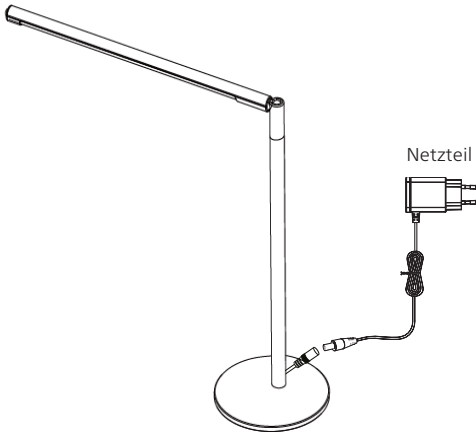

## Bedienung

Drücken Sie den Multifunktionsschalter am Ende des Lampenkopfes, um die Lampe ein- und auszuschalten und zu steuern.

- Kurzer Druck: Ein > 3 Farbtemperaturen:  
6000, 2800, 4000K > Aus

- Langer Druck: Stufenloses  
Helligkeitsdimmung



Memory-Funktion: Der vorherige Dimmwert wird gespeichert und beim nächsten Einschalten wieder aufgerufen.

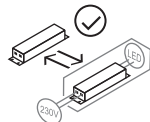

## styro ag

Frauholzstr. 27, CH-6422 Steinen  
Tel. +41 (0)41 833 80 10  
info@styro.ch | www.styro.ch

## EU Distributor | styro GmbH

Industriestr. 2, D-91583 Schillingsfürst  
Tel. +49 9868 98949-0  
verkauf@styro.de | www.styro.de  
produkte@styro.de



## Montage

**HANSA**  
by styro



- 
- 
- 
- 

## Lampeneinstellungen

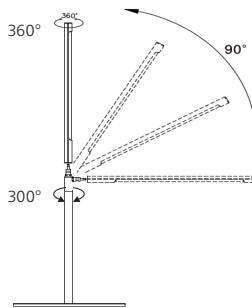

SP20251031



## Technische Daten

Versorgungsspannung:	AC 100-240 V, 50-60 Hz
Licht Leistung:	8W
Lichtstrom:	400 lm
Farbtemperatur:	2800, 4000, 6000 K
Schutzklasse:	II (ohne Netzteil: III)
Schutzart:	IP20
Kabel:	1.5 m
Modellnummer:	41-5011.005 / 006

Dieses Produkt enthält eine Lichtquelle der Energieeffizienzklasse F.

Der Aufbau der Leuchte erlaubt keinen Austausch des Leuchtmittels, da die Gefahr besteht, die Leuchte dabei zu beschädigen. Das Betriebsgerät befindet sich im Netzteil.

# Aura

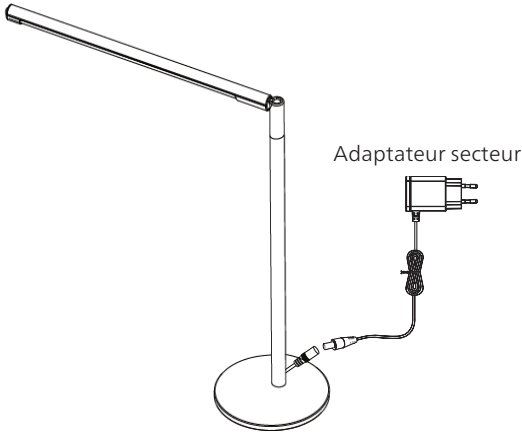

## Fonctionnement

Appuyez sur l'interrupteur multifonction situé à l'extrémité de la lampe pour allumer/éteindre et contrôler la lampe.

- Cycle de pressions brèves : ON > 3 températures de couleur: 6000, 2800, 4000K > Off

- Pression longue : variation continue de luminosité



Fonction mémoire : le niveau de variation précédent est enregistré et rappelé à l'allumage suivant

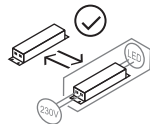

## styro ag

Frauholzstr. 27, CH-6422 Steinen  
Tel. +41 (0)41 833 80 10  
info@styro.ch | www.styro.ch

## EU Distributor | styro GmbH

Industriestr. 2, D-91583 Schillingsfürst  
Tel. +49 9868 98949-0  
verkauf@styro.de | www.styro.de  
produkte@styro.de



## Montage

**HANSA**  
by styro

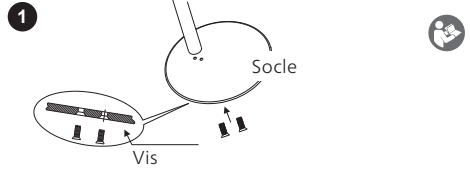

- 

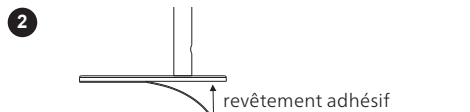
1
- 

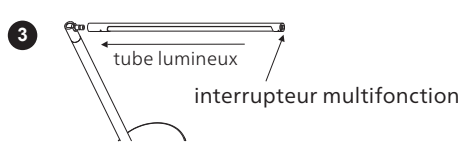
2
- 

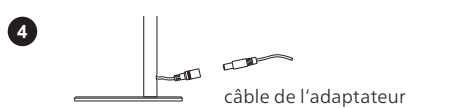
3
- 

4

## Réglages de la lampe

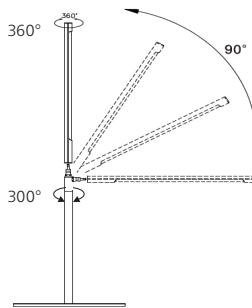

SP20251031



## Données techniques

Tension d'alimentation: AC 100-240 V, 50-60 Hz  
Puissance d'éclairage: 8W  
Flux lumineux: 400 lm  
Temp. de couleur: 2800, 4000, 6000 K  
Classe de protection: II (sans adaptateur: III)  
Indice de protection: IP20  
Câble: 1.5 m  
Numéro d'article: 41-5011.005 / 006

Ce produit contient une source lumineuse de classe d'efficacité énergétique F.

La construction du luminaire ne permet pas de remplacer la source lumineuse, car il y a un risque d'endommager le luminaire. L'appareillage de commande se situe dans l'adaptateur secteur.