





Novano

Operation

-  **Short Touch** to turn **on / off** the lamp
Long touch (>2 sec.) for delayed turn off, after 40 min.
-  **Colour temperature change:**
5 steps (3000, 3500, 4000, 5000, 6500 K)
-  **Dimmer:**
Touch to stepless adjust brightness: (10%–100%) 

Memory function: previous colour temp. and dimming level are recalled at following turn on

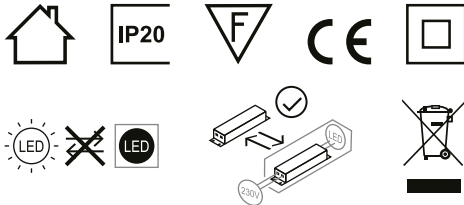

styro ag
Frauholzstr. 27, CH-6422 Steinen
Tel. +41 (0)41 833 80 10
info@styro.ch | www.styro.ch

EU Distributor | styro GmbH
Industriestr. 2, D-91583 Schillingsfürst
Tel. +49 9868 98949-0
verkauf@styro.de | www.styro.de



Installation

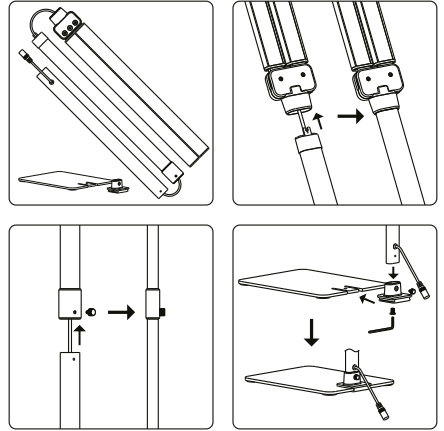

Control panel

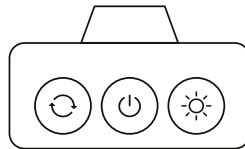

SP20240719



Technical data

Voltage:	AC 220-240 V, 50-60 Hz
Lighting power:	20 W
Luminous flux:	1200 lm
Colour temp.:	3000–6500 K
Protection class:	II (w/o adapter III)
Ingress protection:	IP20

Model number: 41-5011.009

This product contains a light source of energy efficiency class F

The construction of the luminaire does not allow the lighting source to be replaced, as there is a risk of damaging the luminaire. The operating device is in the adapter.

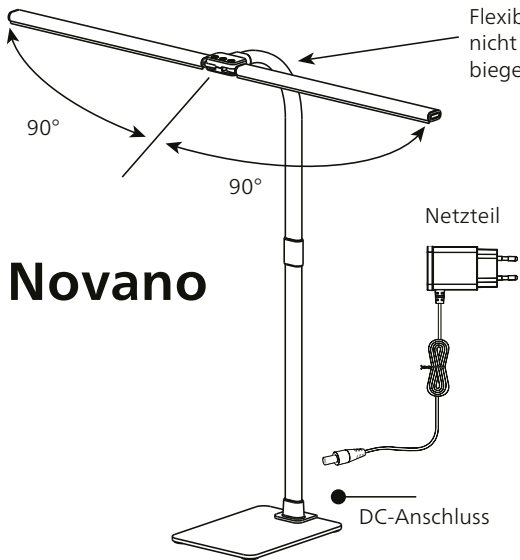

Novano

Bedienung



Kurze Berührung zum Ein-/Ausschalten
Lange Berührung (>2 Sek.) für verzögertes Ausschalten nach 40 Min.



Farbtemperaturwechsel:
5 Stufen (3000, 3500, 4000, 5000, 6500 K)



Dimmer:
Berühren, um die Helligkeit stufenlos einzustellen: (10% – 100%) 

Memory-Funktion: vorherige Farbtemperatur und Dimmstufe werden beim nächsten Einschalten wieder aufgerufen

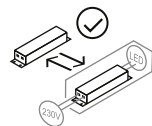

styro ag

Frauholzstr. 27, CH-6422 Steinen
Tel. +41 (0)41 833 80 10
info@styro.ch | www.styro.ch

EU Distributor | styro GmbH

Industriestr. 2, D-91583 Schillingsfürst
Tel. +49 9868 98949-0
verkauf@styro.de | www.styro.de



Montage

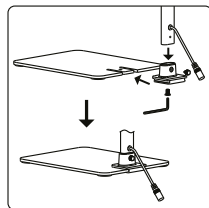
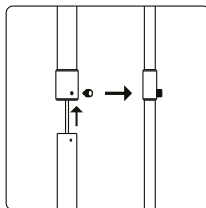
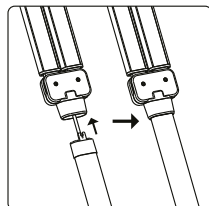
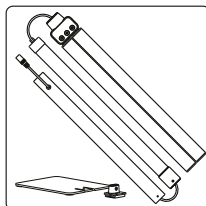

Berührungssteuerung

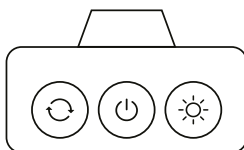

SP20240719



Technische Daten

Versorgungsspannung: AC 220-240 V, 50-60 Hz
Licht Leistung: 20W
Lichtstrom: 1200 lm
Farbtemperatur: 3000 – 6500 K
Schutzklasse: II (ohne Netzteil: III)
Schutzart: IP20

Modellnummer: 41-5011.009

Dieses Produkt enthält eine Lichtquelle der Energieeffizienzklasse F.

Der Aufbau der Leuchte erlaubt keinen Austausch des Leuchtmittels, da die Gefahr besteht, die Leuchte dabei zu beschädigen. Das Betriebsgerät befindet sich im Netzteil.

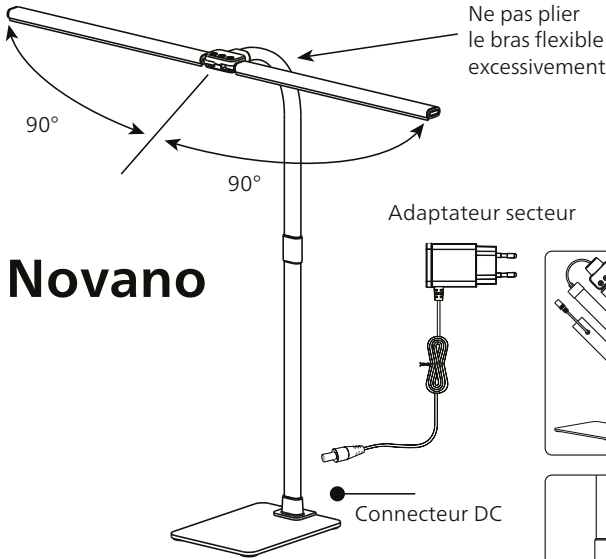

Novano

Fonctionnement



Toucher bref pour allumer / éteindre
Toucher long (>2 s) pour un arrêt différé après 40 minutes



Changement de teinte de lumière :
 5 niveaux (3000, 3500, 4000, 5000, 6500 K)



Variateur :
 Toucher pour une variation continue de la luminosité (10 % – 100 %) 

Fonction mémoire : La teinte de lumière et le niveau de variation précédents sont rappelés à l'allumage suivant

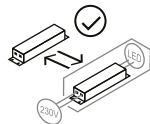

styro ag

Frauholzstr. 27, CH-6422 Steinen
 Tel. +41 (0)41 833 80 10
 info@styro.ch | www.styro.ch

EU Distributor | styro GmbH

Industriestr. 2, D-91583 Schillingsfürst
 Tel. +49 9868 98949-0
 verkauf@styro.de | www.styro.de



Ne pas plier le bras flexible excessivement

Montage

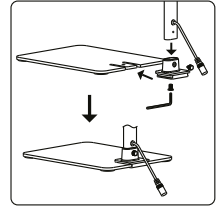
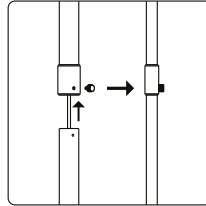
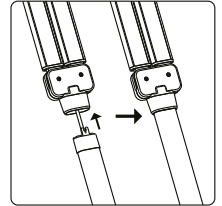
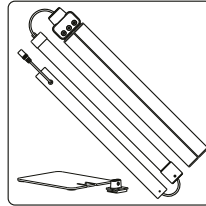

Panneau de contrôle

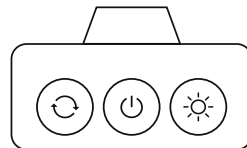

SP20240719



Données techniques

Tension d'alimentation : AC 220-240 V, 50-60 Hz
 Puissance d'éclairage : 20 W
 Flux lumineux : 1200 lm
 Temp. de couleur : 3000 – 6500 K
 Classe de protection : II (sans adaptateur : III)
 Indice de protection : IP20

Numéro d'article : 41-5011.009

Ce produit contient une source lumineuse de classe d'efficacité énergétique F.

La construction du luminaire ne permet pas de remplacer la source lumineuse, car il y a un risque d'endommager le luminaire. L'appareillage de commande se situe dans l'adaptateur secteur.